

TDW-Mega 800

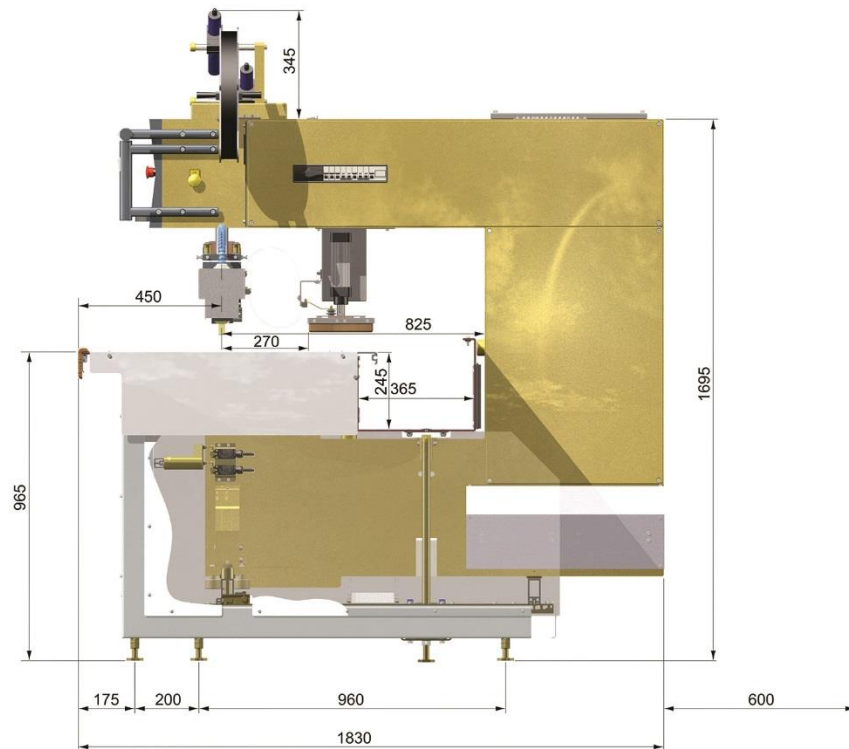

TECHNICAL SPECIFICATIONS

Power requirement – free running	1,3 kW
Power requirement – max/hour	7,6 kW
Emitted power HF maximum on electrode	20 kW
Main fuse – type D	63 A
Standard voltage	3 x 400 V 50 Hz/60 Hz + neutral + earth
Working frequency	27,12 MHz \pm 0,6 %
Transmitting tube - type	ITL 12-1
Transmitting tube - cooling	Air-cooled
Flash protection	Thyristor controlled
Pressure	Max. 2700 kg at min. 7 bar / 101 psi
Maximum air consumption - automatic	190 l/min
Daylight (with a 45 mm high electrode)	70 mm
Pneumatic press with automatic pressure protection system	PSK
Weight of the machine (excl. table)	1100 kg
Max. welding surface each working cycle	800 cm ²
Max. weldable electrode width	400 mm
Computer with 12" touch-screen	Forsstrom™ industrially developed, HF-classified computer
Free space behind the electrode	825 mm
Measurement of table and trough	Optional length, H: 960 mm, W: 1245 mm Trough 365 x 245 mm
Available accessories	Rolls on table, laser, band holder, remote control, extended day-light, collision protection, impulse welding unit, oil-tempering