

TX 500

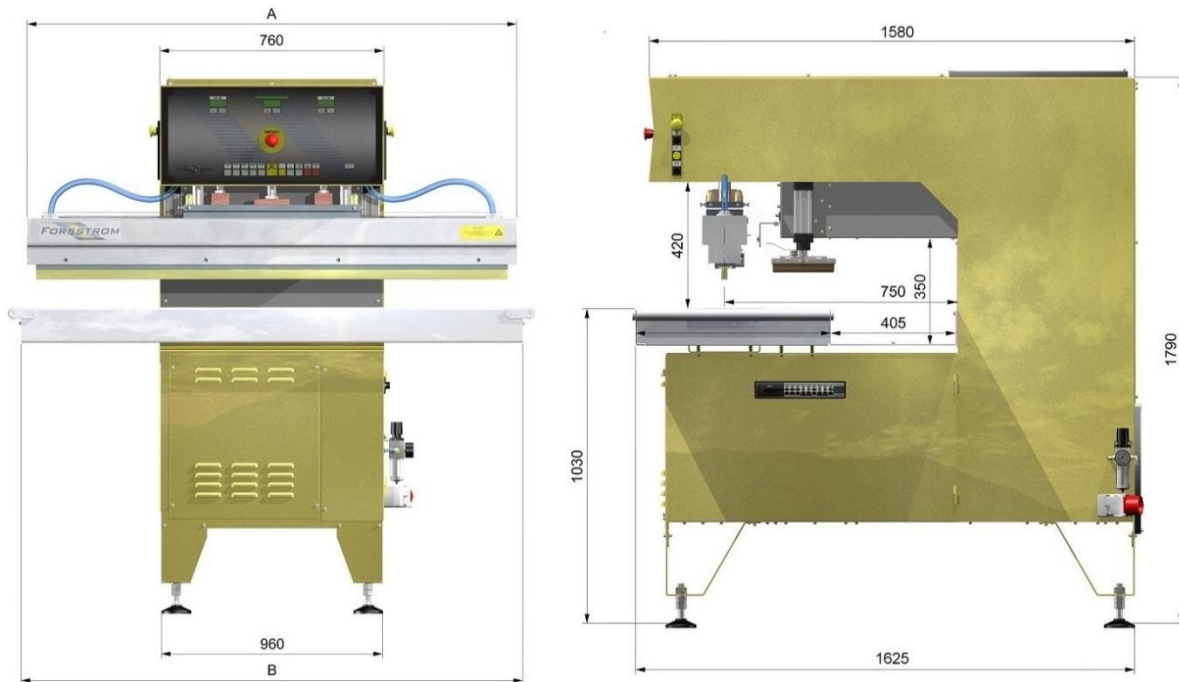

TECHNICAL SPECIFICATIONS

Power requirement – free running	1,3 kW
Power requirement – max/h	6,2 kW/h
Emitted power HF maximum on electrode	12 kW
Main fuse – type D	32 A
Standard voltage	3 x 400 V 50 Hz/60 Hz + neutral + earth
Working frequency	27,12 MHz \pm 0,6 %
Transmitting tube - type	ITL 12-1
Transmitting tube - cooling	Air-cooled
Flash protection	Thyristor controlled
Pressure	Max. 1400 kg at min. 7 bar / 101 psi
Maximum air consumption - automatic	130 l/min
Daylight (with a 45 mm high electrode)	75 mm
Pneumatic press with automatic pressure protection system	PSK
Weight of the machine	750 kg
Max. welding surface each working cycle	500 cm ²
Max. weldable electrode width	200 mm
Computer with 12" touch-screen	Forsstrom™ industrially developed, HF-classified computer
Free space behind the electrode	750 mm
Available accessories	Rolls on table, foot pedal, wheels